

PiTP Lectures

Katrin Becker¹

Department of Physics, Texas A&M University,
College Station, TX 77843, USA

¹kbecker@physics.tamu.edu

Contents

1	Introduction	2
2	String duality	3
2.1	T-duality and closed bosonic strings	3
2.2	T-duality and open strings	4
2.3	Buscher rules	5
3	Low-energy effective actions	5
3.1	Type II theories	5
3.1.1	Massless bosons	6
3.1.2	Charges of D-branes	7
3.1.3	T-duality for type II theories	7
3.1.4	Low-energy effective actions	8
3.2	M-theory	8
3.2.1	2-derivative action	8
3.2.2	8-derivative action	9
3.3	Type IIB and F-theory	9
3.4	Type I	13
3.5	SO(32) heterotic string	13
4	Compactification and moduli	14
4.1	The torus	14
4.2	Calabi-Yau 3-folds	16
5	M-theory compactified on Calabi-Yau 4-folds	17
5.1	The supersymmetric flux background	18
5.2	The warp factor	18
5.3	SUSY breaking solutions	19

These are two lectures dealing with supersymmetry (SUSY) for branes and strings. These lectures are mainly based on ref. [1] which the reader should consult for original references and additional discussions.

1 Introduction

To make contact between superstring theory and the real world we have to understand the vacua of the theory. Of particular interest for vacuum construction are, on the one hand, D-branes. These are hyper-planes on which open strings can end. On the world-volume of coincident D-branes, non-abelian gauge fields can exist. Moreover, D-branes support chiral matter. On the other hand, fluxes, which are higher dimensional generalizations of gauge fields, play an important role.

In one approach to semi-realistic models for particle physics we can start with the 10d heterotic string on a space-time background of the form

$$M_E \times X, \tag{1}$$

where M_E is 4d Minkowski space and X a Calabi-Yau 3-fold. For a particular choice of vector bundle it is possible to obtain GUT gauge groups like E_6 , $SO(10)$ and $SU(5)$. However, besides fields known to exist like non-abelian gauge fields and chiral matter, the 4d spectrum also contains massless scalar fields, the so-called moduli fields. These moduli fields arise from the deformations of X . In the above example we could have compactified on a space X of any size. There is an entire family of solutions labeled by the different shapes and sizes of X . This leads to massless scalar fields in 4d which are ruled out experimentally. Moreover, if the size of X is not determined there is no a priori reason why space-time compactified in the first place. A non-compact 10d space-time looks as natural as compactified space.

Luckily the above compactification is very special. In the generic case vacuum expectation values for fluxes (in this case 3-form flux) could also have been considered as part of the background. In the presence of flux potentials for some moduli fields are generated while preserving SUSY in 4d.

In the context of M-theory or type II compactifications fluxes modify the space-time geometry ‘mildly’. Instead of a direct product the space-time becomes a warped product. An example of a warped product, which we will discuss later in more detail, is an 11d space-time with metric

$$ds^2 = \Delta^{-1}(-dx_0^2 + dx_1^2 + dx_2^2) + \Delta^{1/2}ds_X^2. \tag{2}$$

Here X is some 8d space, which we can take to be a Calabi-Yau 4-fold and $\Delta = \Delta(y)$, the warp factor, is a function depending on the coordinates of X . It turns out that in regions of large warping a large hierarchy of scales can be generated in a natural way. Applied to 4d flux compactifications this idea provides one of the few natural solutions to the hierarchy problem in string theory as will be explained in a forthcoming lecture.

2 String duality

Traditionally there have been 5 consistent superstring theories in 10d (type IIA, IIB, I and the heterotic $SO(32)$ and $E_8 \times E_8$ string theories) and one SUGRA theory in 11d, whose ‘quantum version’ is called M-theory.

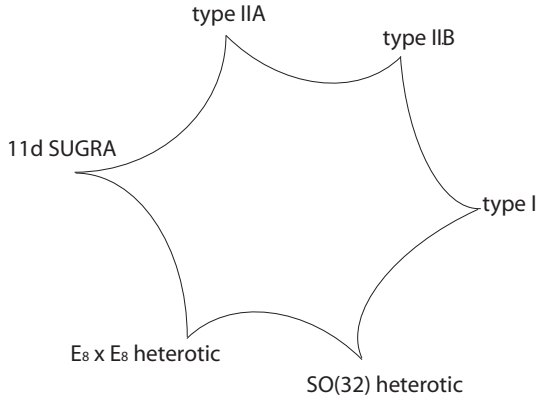

Even though these theories look very different at weak coupling nowadays we believe they are related to each other through a web of string dualities. One theory can be the strong coupling limit of the other. In the figure 11d SUGRA, for example, is believed to be the limit of type IIA string theory in which g_s , the string coupling constant, becomes very large. It is only perturbation theory which causes the theories to look different.

Figure 1: The web of string dualities.

2.1 T-duality and closed bosonic strings

T-duality is the simplest example of string duality and it can be described in perturbation theory for closed bosonic strings. Lets consider a space-time which is flat with one direction compactified on a circle, S^1 , of radius R . T-duality states that the same theory is obtained if the radius of the circle is α'/R .

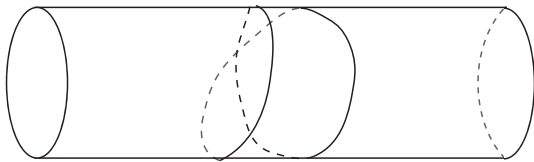

Figure 2: A closed string with $W = 2$

Evidence for T-duality appears in the spectrum. If one direction is a circle the closed string can wind around the compact direction. Associated to this winding is a winding number, $W \in \mathbb{Z}$, which for the string in the in the figure is $W = 2$.

To describe a string winding a W number of times set

$$X(\sigma + 2\pi, \tau) = X(\sigma, \tau) + 2\pi RW, \quad (3)$$

where $-\infty \leq \tau \leq \infty$, $0 \leq \sigma \leq 2\pi$ are the world-sheet coordinates. To satisfy these boundary conditions the zero mode piece includes a term proportional to σ

$$X(\sigma, \tau) = x + RW\sigma + \alpha' \frac{K}{R} \tau + \dots \quad (4)$$

Here the term proportional to τ describes the center of mass momentum in the compact direction. This momentum is quantized and given by $p = K/R$, with $K \in \mathbb{Z}$. Moreover, the dots represent the oscillators.

The states in the spectrum have masses (see ref. [1] for more details)

$$\alpha' M^2 = \alpha' \left[\left(\frac{K}{R} \right) + \left(\frac{WR}{\alpha'} \right)^2 \right] + 2N_L + 2N_R - 4. \quad (5)$$

with $N_R - N_L = WK$. The mass formula is symmetric under the interchange

$$K \leftrightarrow W, \quad R \leftrightarrow \frac{\alpha'}{R}. \quad (6)$$

This is T-duality. It follows that closed bosonic strings compactified on large and small circles have the same mass spectra. This illustrates the idea of string geometry, which is the geometry probed by strings, and which as shown explicitly in the above example differs from the geometry probed by point particles.

There is an alternative way to express T-duality which will be useful later during these lectures. It is found by splitting $X(\sigma, \tau)$ into left movers, depending on $\tau + \sigma$, and right movers, depending on $\tau - \sigma$, according to

$$\begin{aligned} X(\sigma, \tau) &= X_L(\tau + \sigma) + X_R(\tau - \sigma) \\ &= \frac{x}{2} + \left(\alpha' \frac{K}{R} + WR \right) (\tau + \sigma) + \frac{x}{2} + \left(\alpha' \frac{K}{R} - WR \right) (\tau - \sigma) + \dots, \end{aligned} \quad (7)$$

where only the zero-mode piece is shown. T-duality takes

$$X_L \rightarrow X_L, \quad X_R \rightarrow -X_R. \quad (8)$$

2.2 T-duality and open strings

The closed bosonic string is mapped to itself under T-duality. When applied to open strings, T-duality interchanges Neumann (N) and Dirichlet (D) boundary conditions. Indeed, the coordinates of open bosonic strings with N boundary conditions can be expanded in the Fourier series (setting $\alpha' = 1/2$ and taking $0 \leq \sigma \leq \pi$)

$$\begin{aligned} X(\sigma, \tau) &= x + p\tau + i \sum_{n \neq 0} \frac{1}{n} \alpha_n e^{-in\tau} \cos(n\sigma) \\ &= \frac{x + \tilde{x}}{2} + \frac{p}{2}(\tau + \sigma) + \frac{x - \tilde{x}}{2} + \frac{p}{2}(\tau - \sigma) + \dots, \end{aligned} \quad (9)$$

where the zero-mode piece has been split into left- and right-movers. Applying T-duality by changing the sign of the R movers leads to the mode expansion of the dual field

$$\tilde{X}(\sigma, \tau) = \tilde{x} + p\sigma + \sum_{n \neq 0} \frac{1}{n} e^{-in\tau} \sin(n\sigma). \quad (10)$$

From here we can read off the boundary conditions of \tilde{X}

$$\begin{aligned} \tilde{X}(0, \tau) &= \tilde{x}, \\ \tilde{X}(\pi, \tau) &= \tilde{x} + \pi p = \tilde{x} + \pi \frac{K}{R} = \tilde{x} + 2\pi \tilde{R}K. \end{aligned} \quad (11)$$

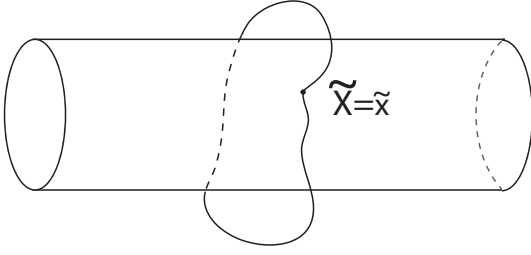

Figure 3: The dual string with $K = 1$.

Here we have used that momentum in the compact direction is quantized as $p = K/R$, where $K \in \mathbb{Z}$ and the dual radius is denoted by $\tilde{R} = 1/(2R)$. The dual string has D boundary conditions in the compact directions. Both ends of the string are fixed at the hyperplane $\tilde{X} = \tilde{x}$ after winding K times the compact direction.

Hyperplanes on which strings can end are called Dp -branes, where p denotes the number of spatial dimensions of the hyperplane. As we will see below in supersymmetric theories Dp -branes are charged and therefore stable due to charge conservation.

The interchange of N and D boundary conditions goes both ways. This can be rephrased into the following rule: if a T-duality is done along an S^1 parallel to a Dp brane, it becomes a $D(p - 1)$ brane. On the other hand, if the T-duality is done transverse to the brane the Dp brane becomes a $D(p + 1)$ brane.

2.3 Buscher rules

So far we have applied T-duality to strings propagating in a flat space-time with one circle direction and found that R gets interchanged with α'/R . It is possible to generalize T-duality to backgrounds specified by a metric $g_{\mu\nu}$, $B_{\mu\nu}$, Φ if in one direction, let's denote it by y , there is an isometry. As discussed in the homework session the data of the T-dual background written in terms of the original background are

$$\begin{aligned}
 \tilde{g}_{yy} &= \frac{1}{g_{yy}}, & \tilde{B}_{y\mu} &= \frac{g_{y\mu}}{g_{yy}} \\
 \tilde{g}_{y\mu} &= \frac{B_{y\mu}}{g_{yy}}, & \tilde{B}_{\mu\nu} &= B_{\mu\nu} + \frac{g_{y\mu}B_{y\nu} - B_{y\mu}g_{y\nu}}{g_{yy}} \\
 \tilde{g}_{\mu\nu} &= g_{\mu\nu} + \frac{B_{y\mu}B_{y\nu} - g_{y\mu}g_{y\nu}}{g_{yy}}, & \tilde{\Phi} &= \Phi - \frac{1}{2} \log g_{yy}.
 \end{aligned} \tag{12}$$

3 Low-energy effective actions

Low-energy effective actions describe the interactions between the massless fields of a given string theory.

3.1 Type II theories

There are two theories with an $N = 2$ local SUSY in $d = 10$, type IIA and type IIB string theory.

3.1.1 Massless bosons

After taking the direct product of L- and R-movers the spectrum of space-time bosons receives contributions from the NS-NS and R-R sectors.

NS-NS sector: The NS-NS sector for type IIA and type IIB strings is the same. After GSO projection the massless states arise from the direct product of two SO(8) vectors

$$\tilde{b}_{-1/2}^i | 0 \rangle_{NS} \otimes b_{-1/2}^j | 0 \rangle_{NS}. \quad (13)$$

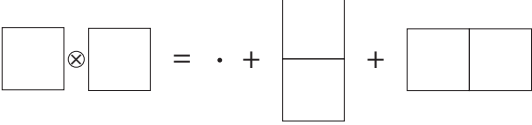

Figure 4: Decomposition of the direct product of two SO(8) vectors into irreducible representations.

Here b are oscillators for the world-sheet spinors with NS boundary conditions and i, j are indices labeling the components of two SO(8) vectors. Taking the direct product and decomposing into irreducible representations gives a singlet, which is the dilaton Φ , a traceless symmetric tensor, which is the metric $g_{\mu\nu}$ and an anti-symmetric rank 2 tensor which is the $B_{\mu\nu}$ field.

R-R sector: The massless bosonic fields of the type IIA string in the R-R sector can be obtained by taking the direct product of two SO(8) spinors of opposite chirality

$$| + \rangle_R \otimes | - \rangle_R. \quad (14)$$

The direct product of two spinors of opposite chirality is decomposed into irreducible tensors according to

$$\mathbf{8} \otimes \mathbf{8}' = \mathbf{56} \oplus \mathbf{8}. \quad (15)$$

The $\mathbf{56}$ representation is an anti-symmetric rank 3 tensor and the $\mathbf{8}$ representation an SO(8) vector.

The massless states in the R-R sector for the type IIB string are obtained by taking the direct product of two spinors of the same chirality

$$| + \rangle_R \otimes | + \rangle_R. \quad (16)$$

It is decomposed as

$$\mathbf{8} \otimes \mathbf{8} = \mathbf{35}_+ \oplus \mathbf{28} \oplus \mathbf{1}. \quad (17)$$

These are the degrees of freedom of rank 4, 2 and 0 tensors. Note that the rank 4 tensor only has 35 components, the reason being that the corresponding 5-form field strength is self-dual in ten-dimensions. The self-duality constraint eliminates 1/2 of the components.

3.1.2 Charges of D-branes

Recall that a vector $A = A_\mu dx^\mu$ couples naturally to a particles world-line via

$$S_A = q \int d\tau A_\mu \frac{dx^\mu}{d\tau} = q \int A. \quad (18)$$

D-branes carry R-R charges. The above interaction generalizes naturally to tensors of higher rank. So for example, a rank 3 tensor couples naturally to a membrane or D2-brane since the 3-form can be integrated over a 1+2 dimensional world-volume. In general, a $C^{(p+1)}$ form couples to a Dp -brane via the interaction

$$S_p \sim \int_{Dp} C^{(p+1)}. \quad (19)$$

Because of charge conservation the corresponding Dp -branes are stable.

Type IIA string theory therefore contains stable D2 and D0 branes which are charged under $C^{(3)}$ and $C^{(1)}$. The magnetic duals are D4 and D6 branes. The D8 brane also appears but has no propagating degrees of freedom. So type IIA contains Dp branes with p even.

On the other hand type IIB contains Dp -branes with p odd. $C^{(0)}$, $C^{(2)}$ and $C^{(4)}$ couple to D(-1), D1 and D3 branes. The magnetic duals are D7 and D5 branes while the D3 brane is self-dual. The D9 brane is non-dynamical but can lead to consistency requirements as we will later see.

3.1.3 T-duality for type II theories

Recall that under T-duality in the X^9 direction

$$X_L^9 \rightarrow X_L^9, \quad X_R^9 \rightarrow -X_R^9. \quad (20)$$

In the RNS formalism world-sheet supersymmetry requires the world-sheet spinors ψ^9 to transform in the same way as the bosonic partners. So

$$\psi_L^9 \rightarrow \psi_L^9, \quad \psi_R^9 \rightarrow -\psi_R^9. \quad (21)$$

This transformation changes the chirality of the right moving ground state in the R sector. As a result under T-duality type IIA and type IIB get interchanged. Note that this teaches us how T-duality acts on the fields. Indeed, under T-duality along the brane

$$S_{Dp} \sim \int_{Dp} C^{(p+1)} \rightarrow \int_{D(p-1)} C^{(p)}. \quad (22)$$

Therefore T-duality in the y direction acts on the fields according to

$$\begin{aligned} C_{i_1 \dots i_n y}^{(n+1)} &\rightarrow C_{i_1 \dots i_n}^{(n)} + \dots \\ C_{i_1 \dots i_n}^{(n-1)} &\rightarrow C_{i_1 \dots i_{n-1} y}^{(n)} + \dots, \end{aligned} \quad (23)$$

where the \dots contain terms of higher order in the fields.

3.1.4 Low-energy effective actions

The low-energy effective actions can be written in the form

$$S = S_{NS} + S_R + S_{CS}, \quad (24)$$

using the notation in ref. [1]. These actions are constructed by requiring a local $N = 2$ supersymmetry in $d = 10$. Here we note that S_{NS} , the part of the action involving NS-NS fields only, is determined by the following requirements: it should be

- 1) written in terms of 2 derivatives
- 2) invariant under diffeomorphisms
- 3) invariant under gauge transformations of the B field, *i.e.* $B \rightarrow B + d\Lambda$,
- 4) invariant under T-duality. Indeed, note that T-duality exchanges type IIA and type IIB but the NS-NS sector is the same for the two theories. Therefore if we compactify, say type IIA on a circle of radius R , T-dualize and work out the metric in terms of the dual variables we should get the same result.

Imposing these constraints leads to an action which up to total derivatives is

$$S_{NS} \sim \int d^{10}x \sqrt{-g} e^{-2\Phi} \left(R + 4 | \nabla \Phi |^2 - \frac{1}{2} | H |^2 \right), \quad (25)$$

as you are asked to verify in a homework problem.

3.2 M-theory

Closely related to type IIA string theory is M-theory, which is the ‘quantum gravity theory’ whose low-energy limit is 11d SUGRA. The bosonic fields are a metric g_{MN} , and an anti-symmetric rank 3 tensor C_3 .

3.2.1 2-derivative action

To leading order in the derivative expansion the action for the bosonic fields is

$$2\kappa_{11}^2 S = \int d^{11}x \sqrt{-g} \left(R - \frac{1}{2} | G_4 |^2 \right) - \frac{1}{6} \int C_3 \wedge G_4 \wedge G_4. \quad (26)$$

Compactification of 11d SUGRA on a circle leads to type IIA string theory. To describe such a circle compactification the 11d metric is assumed to be a S^1 fibred over a 10d base. The most general form of such a metric is

$$ds^2 = e^{-2\Phi/3} g_{\mu\nu} dx^\mu dx^\nu + e^{4\Phi/3} (dx^{11} + A_\mu dx^\mu)^2, \quad x^{11} \sim x^{11} + 2\pi R \quad (27)$$

Here $\Phi = \Phi(x)$ becomes the type IIA dilaton, $A = A(x)$ the 1-form and $g_{\mu\nu}$ is the 10d metric in the string frame. The 11d C_3 field becomes a 3-form $C^{(3)}$ and the NS-NS 2-form $B_{\mu\nu} = C_{\mu\nu 11}^{(3)}$.

It is a good homework problem to work out the action of type IIA SUGRA starting with the action of 11d SUGRA and decomposing the fields as just described.

3.2.2 8-derivative action

In addition to the 2-derivative terms, the M-theory action also contains higher derivative corrections. An example of such a term which is important for flux backgrounds is

$$\delta S = T_2 \int C_3 \wedge X_8, \quad (28)$$

where X_8 is constructed from the curvature 2-form according to

$$X_8 = \frac{1}{(2\pi)^4} \left[-\frac{1}{768} (\text{tr} R^2)^2 + \frac{1}{192} \text{tr} R^4 \right], \quad (29)$$

and T_2 is the membrane tension. X_8 has two properties which we will later use

- 1) it is conformal invariant, *i.e.* if g and g' are two conformally related metrics

$$X_8(g) = X_8(g'). \quad (30)$$

To show this write X_8 in terms of Pontryagin classes according to

$$X_8 = \frac{1}{48} \left(p_2 - \frac{1}{4} p_1^2 \right). \quad (31)$$

It was shown in ref. [4] that Pontryagin classes are conformal invariant.

- 2) when integrated over a Calabi-Yau 4-fold X_8 is proportional to the Euler characteristic χ of the 4-fold

$$\int_{\text{CY4}} X_8 = \frac{\chi}{24}. \quad (32)$$

To prove this² write the Pontryagin classes in terms of Chern classes according to

$$\begin{aligned} p_1 &= c_1^2 - 2c_2, \\ p_2 &= c_2^2 - 2c_1c_3 + 2c_4, \end{aligned} \quad (33)$$

which after using $c_1 = 0$ which holds for Calabi-Yau spaces becomes

$$X_8 = \frac{1}{24} c_4. \quad (34)$$

The Gauss-Bonnet theorem for complex manifolds leads to the desired result.

3.3 Type IIB and F-theory

Classically type IIB SUGRA has an $SL(2, \mathbb{R})$ symmetry acting on the fields. Recall the definition of the special linear group

$$SL(n, \mathbb{R}) = \{A \in GL(n, \mathbb{R}) \mid \det A = 1\}, \quad (35)$$

²See for example ref. [5].

where $GL(n, \mathbb{R})$ is the general linear group, which is the group of real $n \times n$ matrices. Therefore we can represent any $\Lambda \in SL(2, \mathbb{R})$ as

$$\Lambda = \begin{pmatrix} a & b \\ c & d \end{pmatrix}, \quad \det \Lambda = ad - bc = 1. \quad (36)$$

The $SL(2, \mathbb{R})$ transformation acts on $\tau = C^{(0)} + ie^{-\Phi}$ as

$$\tau \rightarrow \frac{a\tau + b}{c\tau + d}, \quad (37)$$

while the 2-forms transform as a doublet

$$B = \begin{pmatrix} C_{\text{RR}}^{(2)} \\ B_{\text{NS}} \end{pmatrix}, \quad B \rightarrow \Lambda B. \quad (38)$$

The metric in the Einstein frame $g_{\mu\nu}^E$ and the 4-form $C^{(4)}$ are invariant. In a quantum theory charge quantization breaks the $SL(2, \mathbb{R})$ symmetry to an $SL(2, \mathbb{Z})$ subgroup.

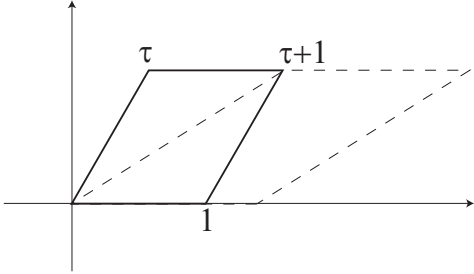

Figure 5: Two equivalent tori related by an $SL(2, \mathbb{Z})$ transformation.

$SL(2, \mathbb{Z})$ is also the group of modular transformations of the torus. As seen in the picture after identifying opposite sides the tori characterized by the complex number τ and $\tau + 1$, for example, are the same. It turns out that the $SL(2, \mathbb{Z})$ transformation of type IIB can be given a geometric interpretation as an modular transformation of a T^2 .

In order to geometrize the $SL(2, \mathbb{Z})$ symmetry consider type IIB string theory in the following background

$$ds_{\text{IIB}}^2 = e^{\Phi/2} \left(-dx_0^2 + \dots + dx_3^2 + \sum_{i,j=4}^9 g_{ij} dy^i dy^j \right) \quad (39)$$

Lets denote the space described by the metric g_{ij} with X . The factor depending on Φ in front of the metric is included since the bracket is the metric in the Einstein frame. The type IIB complex coupling τ is assumed to be constant. This restriction is not really necessary, and we will actually give it up below, but it is sufficient for the present purpose. For constant τ , X can be a Calabi-Yau 3-fold leading to a solution with $N = 2$ SUSY in 4d. Lets relabel one of the Minkowski space coordinates as w_2 and identify periodically

$$x_3 \rightarrow w_2 \simeq w_2 + 2\pi. \quad (40)$$

Applying the Buscher rules the solution can be T-dualized to a type IIA background. The type IIA metric, dilaton and RR 1-form are

$$\begin{aligned} ds_{\text{IIA}}^2 &= e^{\Phi/2} (-dx_0^2 + dx_1^2 + dx_2^2) + e^{-\Phi/2} dw_2^2 + e^{\Phi/2} g_{ij} dy^i dy^j, \\ \Phi_{\text{IIA}} &= \frac{3}{4}\Phi, \\ C^{(1)} &= C^{(0)} dw_2. \end{aligned} \quad (41)$$

Next we lift this solution to M-theory. Since the type IIA background only includes a metric, dilaton and RR 1-form it lifts to a purely geometric background, with no G_4 flux. Recall the relation between the M-theory and type IIA metric

$$ds^2 = e^{-2\Phi_{\text{IIA}}/3} ds_{\text{IIA}}^2 + e^{4\Phi_{\text{IIA}}/3} (dw_1 + C_{w_2}^{(1)} dw_2)^2. \quad (42)$$

Here we have denoted the 11 \rightarrow 10 circle coordinate by w_1 and we are imposing the discrete identifications $w_1 \simeq w_1 + 2\pi$. Using the type IIA data it is easy to verify that the 11d metric is

$$ds^2 = -dx_0^2 + dx_1^2 + dx_2^2 + g_{ij} dy^i dy^j + e^{-\Phi} dw_2^2 + e^{\Phi} (dw_1 + C^{(0)} dw_2)^2. \quad (43)$$

Taking the definition of the complex coupling $\tau = \tau_1 + i\tau_2 = C^{(0)} + ie^{-\Phi}$ into account this metric can be rewritten as

$$ds^2 = -dx_0^2 + dx_1^2 + dx_2^2 + g_{ij} dy^i dy^j + \frac{1}{\tau_2} |dw_1 + \tau dw_2|^2. \quad (44)$$

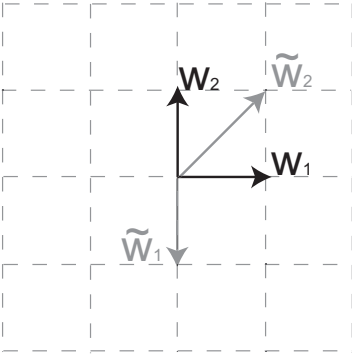

Figure 6: The two sets of vectors define the same lattice and are related by an $SL(2, \mathbb{Z})$ trafo.

The last term in the above expression is the metric of a torus with complex parameter τ and unit volume. This metric is invariant under modular transformations

$$\tau \rightarrow \frac{a\tau + b}{c\tau + d}, \quad (45)$$

up to the diffeomorphism

$$\begin{pmatrix} w_1 \\ w_2 \end{pmatrix} \rightarrow \begin{pmatrix} a & -b \\ -c & d \end{pmatrix} \begin{pmatrix} w_1 \\ w_2 \end{pmatrix} \quad (46)$$

which respect the discrete identifications $w_i \simeq w_i + 2\pi$, $i = 1, 2$.

Recall that ‘this τ ’ is also the type IIB complex coupling. Therefore the $SL(2, \mathbb{Z})$ transformation acting on the torus translates into the $SL(2, \mathbb{Z})$ acting on the IIB fields.

The action of $SL(2, \mathbb{Z})$ on tensor fields can be obtained by decomposing the 3-form into tensors with 9d indices according to

$$C_3 = C^{(3)} + B_2 dw_1 + C_2 dw_2 + B_1 dw_1 \wedge dw_2. \quad (47)$$

After T-duality in the w_2 direction $C^{(3)}$ becomes the type IIB 4-form, B_2 the type IIB NS-NS 2-form, C_2 the type IIB R-R 2-form and B_1 gives off-diagonal components of the metric. Since C_3 is invariant under diffeomorphisms C_2 and B_2 have to transform according to

$$\begin{pmatrix} C_2 \\ B_2 \end{pmatrix} \rightarrow \begin{pmatrix} a & b \\ c & d \end{pmatrix} \begin{pmatrix} C_2 \\ B_2 \end{pmatrix} \quad (48)$$

under eqn. (46), while $C^{(4)}$ and the metric in the Einstein frame are invariant. This is precisely how $SL(2, \mathbb{Z})$ acts on the IIB fields.

It turns out that the condition that τ is constant can be relaxed while preserving SUSY. It is possible to show that an $N = 1$ SUSY in $d = 4$ can be preserved if

- 1) X is a Kähler manifold of complex dimension 3. However, it should not be a Calabi-Yau 3-fold since it is not Ricci flat.
- 2) τ is a holomorphic function of the base coordinates

$$\bar{\partial}\tau = 0, \quad \bar{\partial} = d\bar{y}^i \frac{\partial}{\partial \bar{y}_i}. \quad (49)$$

- 3) The Ricci form of X is related to τ according to

$$\mathcal{R} = i\partial\bar{\partial} \log \det g_{i\bar{j}} = i\partial\bar{\partial} \log \tau_2. \quad (50)$$

Here we have used that X is Kähler.

Beyond this there is an additional generalization possible since the complex dimension of X does not have to be 3 and can be any integer n with $n = 1, 2, \dots$. As long as the conditions 1), 2) and 3) are satisfied the above background is supersymmetric.

When lifted to M-theory the backgrounds with varying τ become purely geometrical. Indeed, the lift to M-theory described above does not require constant τ . Lifting a background with varying τ to M-theory yields the metric

$$ds^2 = -dx_0^2 + dx_1^2 + dx_2^2 + g_{ij} dy^i dy^j + \frac{1}{\tau_2(y)} |dw_1 + \tau(y)dw_2|^2. \quad (51)$$

This is a theory with $N = 2$ SUSY in $d = 3$, and therefore the metric of X together with the torus piece is a metric on an elliptically fibred Calabi-Yau 4-fold, in the so-called semi-flat approximation. This is a good metric away from the singularities of τ . Since it is not clear what it means to T-dualize along singular fibers the metric is expected to be a good description away from the singularities of τ . However, τ is a holomorphic parameter and, in general, it is expected to have singularities unless constant. Close to the singularities the above metric will not be a good description and the isometries in the w_1 and w_2 directions will break down. The case $n = 1$ is also known as stringy cosmic string metric and the above expression is an approximation to the metric of K3.

3.4 Type I

The type IIB string is left-right symmetric. So for example, the massless states in the NS-NS and R-R sectors are

$$\tilde{b}_{-1/2}^i | 0 \rangle_{\text{NS}} \otimes b_{-1/2}^j | 0 \rangle_{\text{NS}}, \quad | + \rangle_{\text{R}} \otimes | + \rangle_{\text{R}}. \quad (52)$$

If one state appears in the spectrum also the state obtained by interchanging left- and right-movers. An operator which exchanges left- and right-movers is the world-sheet parity

$$\Omega : \sigma \rightarrow 2\pi - \sigma. \quad (53)$$

The spectrum of the type I string theory is obtained by keeping Ω invariant states. In the NS-NS sector only the dilaton and metric are invariant while the NS-NS 2-form is projected out. Taking Fermi statistics into account it follows that in the R-R sector only $C^{(2)}$ is invariant, while $C^{(4)}$ and $C^{(0)}$ are projected out.

The type IIB space-time fermions are obtained by taking the direct product of the states in the NS and R sectors according to

$$\begin{aligned} &\tilde{b}_{-1/2}^i | 0 \rangle_{\text{NS}} \otimes | + \rangle_{\text{R}}, \\ &| + \rangle_{\text{R}} \otimes b_{-1/2}^j | 0 \rangle_{\text{NS}}. \end{aligned} \quad (54)$$

These are interchanged under Ω . As a result one linear combination is left invariant and the other is projected out. Accordingly, the type I string has an $N = 1$ SUSY in $d = 10$ as opposed to the type IIB string which has $N = 2$ SUSY.

It turns out that the theory obtained by keeping only Ω invariant states is not consistent. The operation of modding out by Ω introduces an $O9$ plane into the theory. Such an $O9$ plane carries -16 units of D9 brane charge. Indeed, the general relation between the charge carried by an O_p plane and a D_p brane is

$$Q_{O_p} = -2^{p-5} Q_{D_p}. \quad (55)$$

Consistency requires the total D9 brane charge to vanish. Only the combined system of one $O9$ plane and 16 D9 branes is consistent. On the world-volume of 16 D9 branes there is an $SO(32)$ gauge theory (see for example refs. [2] and [3] for more details.).

The massless bosonic fields of the type I string are

$$g_{\mu\nu}, \Phi, C^{(2)}, A_\mu, \quad (56)$$

where A_μ is an $SO(32)$ gauge field.

3.5 $SO(32)$ heterotic string

The type I string is not the only supersymmetric string theory with the above field content in $d = 10$. The other theory is the $SO(32)$ heterotic string. The low-energy effective actions of the type I and $SO(32)$ heterotic string are related by the strong-weak coupling duality

$$\begin{aligned} e^{\Phi_I} &= e^{-\Phi_H}, \\ g_{\mu\nu}^I &= e^{-\Phi_H} g_{\mu\nu}^H, \end{aligned} \quad (57)$$

where $g_{\mu\nu}$ is the string frame metric in the corresponding theory. This equivalence can be explicitly checked at the level of low-energy effective actions. However, note that the relation between the type I and heterotic dilaton fields implies

$$g_s^I g_s^H = 1. \quad (58)$$

As a result if one theory is weakly coupled the other is strongly coupled. This is the reason why such a duality is difficult to check and is at most a conjecture. Some tests have been made and no discrepancy has been found. So for example, it is possible to show that the tension of the type I D1 string becomes the tension of the heterotic string at strong coupling.

4 Compactification and moduli

The heterotic string on $M_4 \times X$, leads to unbroken SUSY in 4d if there are solutions of

$$\delta_\epsilon(\text{fermi}) = 0. \quad (59)$$

One solution with unbroken $N = 1$ SUSY is

$$H_3 = 0, \quad \Phi = \text{const.}, \quad \nabla_m \epsilon = 0, \quad (60)$$

together with some appropriate choices of gauge fields. Here H_3 is the field strength corresponding to the rank 2 anti-symmetric tensor. In this case X is a Calabi-Yau 3-fold. Deformations of X lead to massless scalar fields in 4d, the moduli.

4.1 The torus

Lets consider Calabi-Yau 1-folds, *i.e.* a T^2 first.

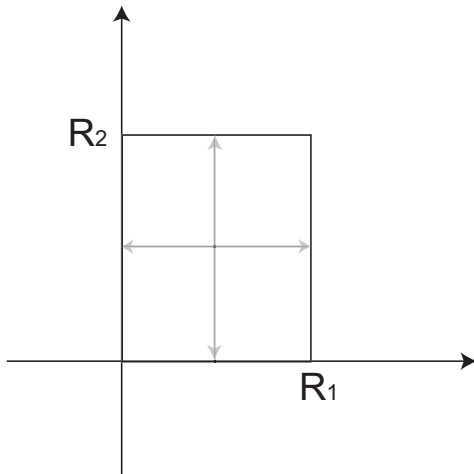

Figure 7: A square torus and examples of A- and B-cycles.

Lets start with a square torus. It is obtained by identifying opposite sides of the parallelogram with sides lengths R_1 and R_2 . There are two ways of deforming this T^2 so that it remains a T^2 . We can change R_1 or R_2 . We can repackage R_1 and R_2 into imaginary fields

$$\tau = i \frac{R_2}{R_1}, \quad \rho = i R_1 R_2. \quad (61)$$

τ is an example of complex structure parameter and ρ of Kähler structure parameter.

Note that T-duality exchanges τ and ρ .

It is possible to rewrite τ in a way that later can be generalized to coordinates on the complex structure moduli space of Calabi-Yau 3-folds. First one introduces the holomorphic 1-form

$$\Omega = R_1 dw_1 + R_2 dw_2, \quad (62)$$

and considers the two cycles of the T^2 , the A-cycle and the B-cycle as shown in the figure above. Then

$$\tau = \frac{\oint_A \Omega}{\oint_B \Omega}. \quad (63)$$

In general, τ and ρ are complex. An angle θ , as shown in the figure, is also possible. Such a torus is characterized by a complex number τ and overall scale ρ_2 .

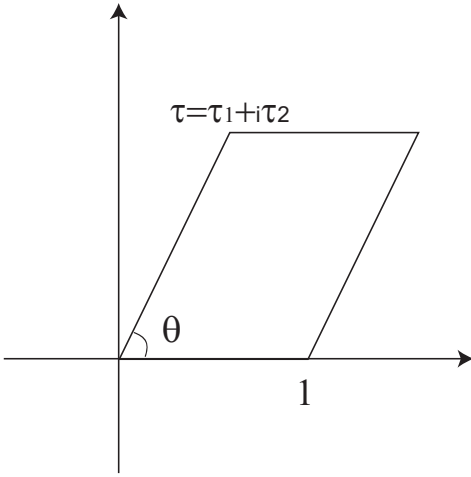

Figure 8: A torus.

On such a T^2 choose the metric

$$ds^2 = \frac{\rho_2}{\tau_2} |dw_1 + \tau dw_2|^2 \quad (64)$$

with $w_i \sim w_i + 2\pi$, $i = 1, 2$. Reading off the metric gives

$$g = \begin{pmatrix} g_{11} & g_{12} \\ g_{21} & g_{22} \end{pmatrix} = \frac{\rho_2}{\tau_2} \begin{pmatrix} 1 & \tau_1 \\ \tau_1 & \tau_1^2 + \tau_2^2 \end{pmatrix}, \quad (65)$$

or inverting

$$\tau = \frac{g_{12}}{g_{22}} + i \frac{\sqrt{\det g}}{g_{22}}. \quad (66)$$

This is the complex structure parameter.

In general, the Kähler structure parameter has an imaginary part given by the size and a real part given by the B -field

$$\rho = \rho_1 + i\rho_2 = B_{21} + i\sqrt{\det g}. \quad (67)$$

Deformations of the T^2 can be done either by changing τ or by changing ρ . These can be done independently.

Note that T-duality in one of the directions, say the w_2 direction, acts as

$$\tau \leftrightarrow \rho, \quad (68)$$

i.e. it interchanges complex and Kähler structure parameters. This duality generalizes to Calabi-Yau 3-folds where it becomes mirror symmetry, which then also interchanges complex and Kähler structure parameters.

When compactifying on a torus τ and ρ appear as massless scalar fields. The kinetic term has a normalization which is not standard but rather given in terms of the two

Kähler potentials

$$\begin{aligned}
 K_\tau &= -\log \left(i \int \Omega \wedge \bar{\Omega} \right) \\
 K_\rho &= -\log \mathcal{J},
 \end{aligned}
 \tag{69}$$

where $\mathcal{J} = B + iJ$ is the complexified Kähler form, and $J = ig_{a\bar{b}}dy^a \wedge dy^{\bar{b}}$ is the Kähler form.

4.2 Calabi-Yau 3-folds

Calabi-Yau 3-folds are obviously more involved than a simple torus but some of the results described above do generalize. For Calabi-Yau 3-folds the number of complex structure parameters is $h^{1,2}$, where in general $h^{p,q}$ are the Hodge numbers of the Calabi-Yau. This results in complex fields in 4d, t^i , $i = 1, \dots, h^{1,2}$. The number of Kähler structure parameters is $h^{1,1}$ giving rise to a number of complex fields, K^i , $i = 1 \dots, h^{1,1}$, after taking the B field into account.

Mirror symmetry for Calabi-Yau 3-folds exchanges complex structure and Kähler structure parameters.

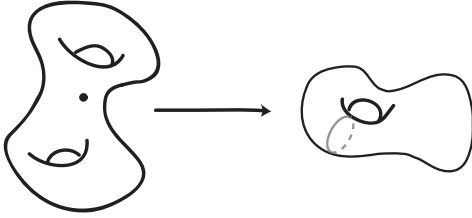

Figure 9: Mirror symmetry maps a BPS state obtained from a D0 brane on X with the state obtained by wrapping a D3 brane on a supersymmetric 3-cycle in \tilde{X} .

A proposal to prove mirror symmetry for Calabi-Yau 3-folds using T-duality is due to Strominger, Yau and Zaslow (SYZ). Consider type IIA compactified on a Calabi-Yau 3-fold X . A BPS state is obtained by considering a D0 brane on X . Mirror symmetry states that there is a mirror Calabi-Yau, let's denote it by \tilde{X} , which leads to the same physics in 4d after compactifying the type IIB theory on it. How can the state mirror to the D0 brane be obtained in type IIB?

The natural guess is to take the Dp branes of type IIB (so p is odd) and wrap them around cycles of \tilde{X} . A Calabi-Yau 3-fold has no 1- or 5-cycles. As a result only D3 branes wrapped on supersymmetric 3-cycles are relevant. As we have learned in the first lecture 3 T-dualities performed transverse to the brane transform a D0 brane into a D3 brane. Therefore SYZ conjectured that Calabi-Yau 3-folds which are T^3 fibrations have a mirror which is obtained by performing 3 T-dualities on the T^3 fibers.

As for the case of the torus, also in the Calabi-Yau 3-fold case deformations of the internal spaces lead to moduli fields, which are massless scalar fields in 4d. A potential for these scalar fields can be generated by considering a generic string theory compactification which besides a metric also includes expectation values for tensor fields, or fluxes.

5 M-theory compactified on Calabi-Yau 4-folds

Some of the simplest and ‘cleanest’ examples of flux backgrounds can be constructed as compactifications of M-theory to 3d. These can be used as a starting point to obtain many flux backgrounds via duality. Examples include type IIB on $M_4 \times X$ with flux or compactifications of heterotic strings on torsional geometries.

The equations of motion of 11d SUGRA and the conditions for unbroken SUSY are solved by

$$\begin{aligned} ds^2 &= -dx_0^2 + dx_1^2 + dx_2^2 + ds_X^2, \\ G_4 &= 0. \end{aligned} \tag{70}$$

where X is a Calabi-Yau 4-fold. Variations of the Calabi-Yau metric can be done by deforming

- 1) the complex structure, which gives rise to complex fields

$$T_i, \quad i = 1, \dots, h^{3,1}, \tag{71}$$

- 2) or the Kähler structure, which gives rise to real fields

$$K_i, \quad i = 1, \dots, h^{1,1}. \tag{72}$$

If G_4 vanishes these fields are massless and their expectation values are arbitrary. However, the flux cannot vanish in general. To see this recall that there is an 8-derivative correction to the 11d SUGRA action given by

$$\delta S = T_2 \int C_3 \wedge X_8, \tag{73}$$

which modifies the equations of motion of C_3

$$d \star G_4 = -\frac{1}{2} G_4 \wedge G_4 - 2\kappa_{11}^2 T_2 X_8. \tag{74}$$

Now we use the fact that in M-theory flux backgrounds exist even if the internal manifold is compact, non-singular and no explicit brane sources are used. Integrating over the Calabi-Yau 4-fold leads to

$$\int_{\text{CY4}} G_4 \wedge G_4 = -4\kappa_{11}^2 T_2 \int_{\text{CY4}} X_8 \sim \chi. \tag{75}$$

So to make sense of compactifications on Calabi-Yau 4-folds with non-vanishing Euler characteristic, G_4 flux has to be taken into account as part of the background.

5.1 The supersymmetric flux background

A supersymmetric flux background is specified by

- 1) the space-time metric

$$ds^2 = \Delta^{-1}(-dx_0^2 + dx_1^2 + dx_2^2) + \Delta^{1/2} ds_X^2, \quad (76)$$

where X is a Calabi-Yau 4-fold and $\Delta = \Delta(y)$ is the warp factor which is a function of the Calabi-Yau coordinates.

- 2) a flux with components on the external space-time

$$G_{m012} = \partial_m \Delta^{-3/2}, \quad (77)$$

- 3) flux with components on X satisfying

$$G_{(2,2)} \wedge J = 0, \quad (78)$$

where (p, q) denotes the number of holomorphic and anti-holomorphic indices and J is the Kähler form. All other components of G_4 vanish.

5.2 The warp factor

The conditions 1), 2) and 3) provide one solution of $\delta_\epsilon(\text{fermi}) = 0$ with an $N = 2$ SUSY in 3d. These conditions are satisfied for arbitrary Δ . But the equations of motion are not solved yet since a solution of the SUSY constraints is, in general, not directly a solution of the equations of motion. The Bianchi identity also needs to be imposed. We will impose the Bianchi identity on the 7-form $G_7 = \star G_4$, which is also the equation of motion for C_3 . Taking G_7 to have components on X or equivalently G_4 to have components in the 012 directions gives

$$d \star_8 d\Delta^{3/2} = -\frac{1}{2} G_4 \wedge G_4 - 2\kappa_{11}^2 T_2 X_8, \quad (79)$$

where \star_8 is the Hodge star operator on X . Now recall that X_8 is conformal invariant. The overall factor of $\Delta^{1/2}$ in front of the metric of X drops out. The only dependence on Δ is on the left hand side of the above equation. This is a Laplace equation for Δ which on a compact space is solvable if the right hand side is orthogonal to the zero mode of the Laplacian. A solution can, for example, be explicitly constructed if we know the Green's function of X .

Note that, in general, there will be corrections to eqn. (79) to all orders in the derivative expansion. However, equations like this are solved in perturbation theory, the expansion parameter being the inverse size of X which is also an expansion in the Planck length l_p . Lets denote the size by L^8 . The warp factor is expanded as

$$\Delta = \Delta_{(0)} + \Delta_{(1)} + \dots, \quad (80)$$

where $\Delta^{(0)}$ is $O(1)$ and according to (79) solves

$$d \star_8 d\Delta_{(0)}^{3/2} = 0, \quad (81)$$

and is therefore constant. To next order

$$d \star_8 d\Delta_{(1)}^{3/2} = -\frac{1}{2}G_4 \wedge G_4 - 2\kappa_{11}^2 T_2 X_8, \quad (82)$$

where $\Delta^{(1)}$ is $O(L^{-6})$. In this equation all terms are of the same order in L . Corrections to eqn. (79) arising from, for example, additional higher derivative terms in the M-theory effective action are sub-leading in the L expansion.

5.3 SUSY breaking solutions

Besides the supersymmetric solutions it is also possible to describe vacua with a vanishing cosmological constant and broken SUSY. Indeed, the equations of motion are solved for any internal flux which is self-dual, *i.e.*

$$G_4 = \star_8 G_4, \quad (83)$$

if conditions 1) and 2) are satisfied. Besides the SUSY preserving solutions described above this condition is also solved by SUSY breaking solutions for which $G_4 \sim J \wedge J$ or $G_4 \sim \Omega + \bar{\Omega}$, where Ω is the holomorphic (4,0) form.

References

- [1] K. Becker, M. Becker and J. H. Schwarz, “String theory and M-theory: a modern introduction,” *Cambridge University Press* (2007).
- [2] J. Polchinski, “String theory” Vol. 1 + 2, *Cambridge University Press*, (1998).
- [3] C. V. Johnson, “D-Branes,” *Cambridge University Press* (2003)
- [4] S. S. Chern and J. Simons, “Characteristic forms and geometric invariants,” *Annals Math.* **99**, 48 (1974).
- [5] T. Eguchi, P. B. Gilkey and A. J. Hanson, “Gravitation, gauge theories and differential geometry,” *Phys. Rept.* **66**, 213 (1980).